









Ficha técnica

Rueda ZV-POL 2-2366

Codigo				Tipo cojinete Eje					
2-2366	80	100	32	—	105x80	86/80x60	8	110	77



Características

Chapa de acero hasta 4mm de espesor.
Acabado cincado brillante.
Soporte embutido con doble hilera de bolas.
Modelo de uso universal para cargas medias.
Fabricadas según normas europeas EN 12530/12532.

Datos técnicos

Diámetro: 80 mm
Carga: 100 kg
Tipo de cojinete: Cojinete Liso
Ancho de Banda de rodadura: 32 mm
Medidas de placa superior: 105x80 mm
Distancia entre agujeros: 86/80x60 mm
Diámetro agujero sujeción platina: 8 mm
Altura total: 110 mm
Radio de giro: 77 mm

Archivos CAD

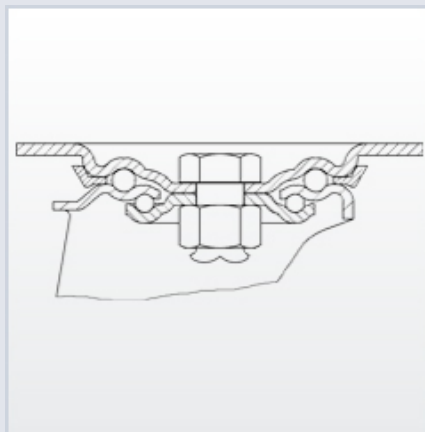

Rueda

POL (Poliuretano)
Núcleo de poliamix y banda de poliuretano marrón(90° shore A)
Rango de temperatura: -25° ÷ +80°

Productos relacionados

