

SIMONWORK BT3 BOX 1200

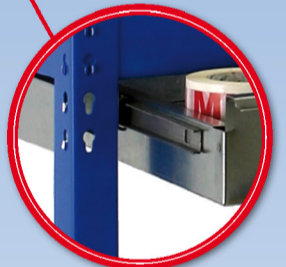

144,5 x 121 x 61 cm
56.9" x 47.6" x 24.0"

5 Años Garantía
 Years Guarantee
 Jahre Garantie
 Ans Garantie
SIMONRACK

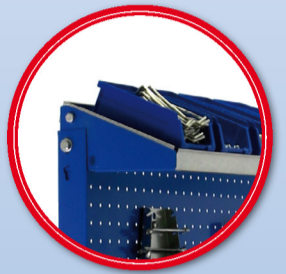
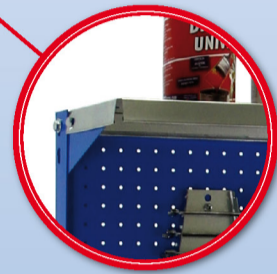

144,5 cm (56.9")

60,3 cm (23.7")

84,2 cm (33.1")

61 cm (24.0")

121 cm (47.6")

400 kg
(880 lb)

35 kg (80 lb)

250 kg
(550 lb)

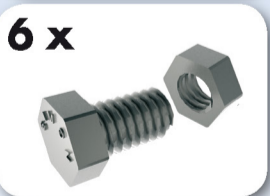
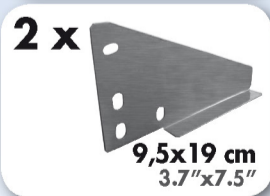
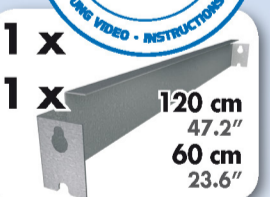
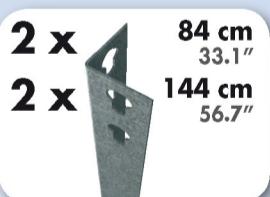

ESTANTERIAS SIMON S.L. B.50.556.463
 PG. ALFAMEN C/ POLIGONO C. Nº3
 ALFAMEN (ZARAGOZA)



www.simonrack.com



INSTRUCCIONES
 INSTRUCTIONS
 ANLEITUNG
 INSTRUCTIONS

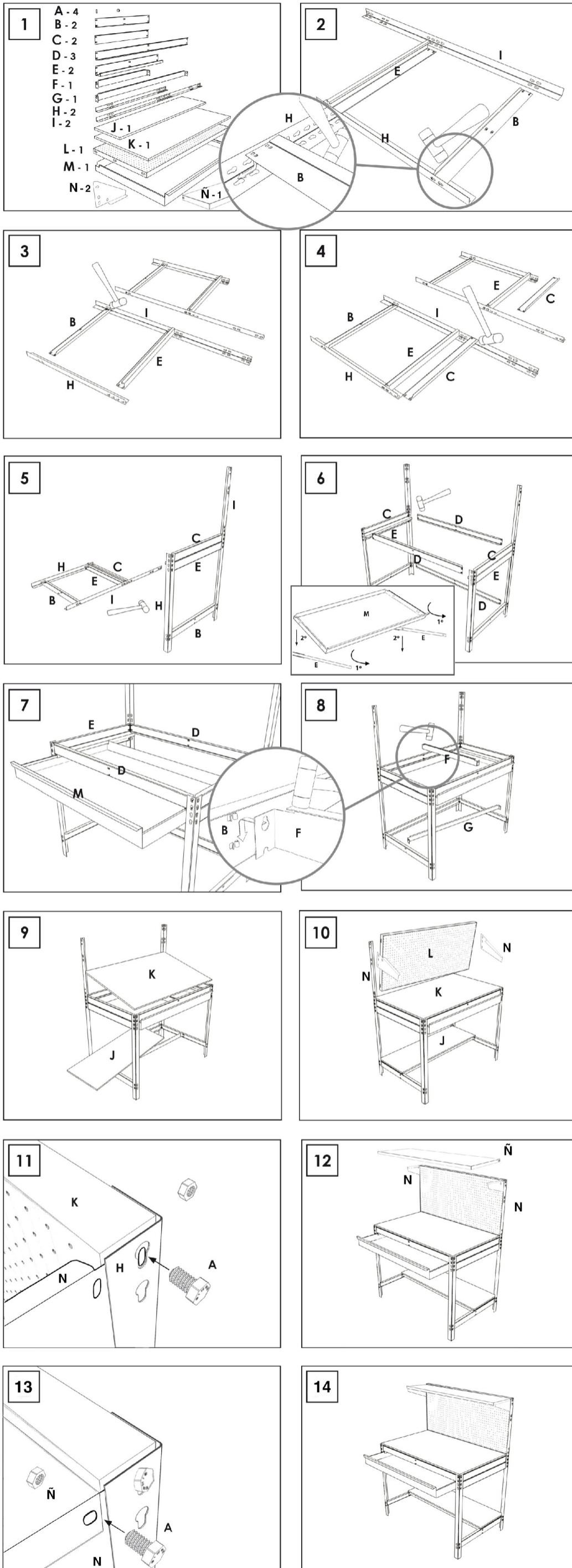

SIMONCLASSIC



SIMONCLICK



SIMONTALLER



SIMONAUTO



SIMONWORK



SIMONLOCKER

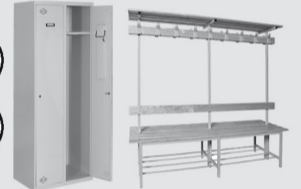

SIMONOFFICE



SIMONHOME

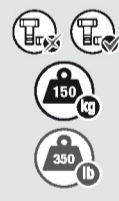

SIMONGARDEN



SIMONTITÁN



SIMONINOX



SIMONINDUSTRIAL

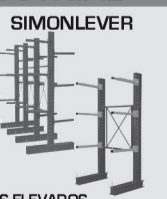

ALTILLOS Y PASILLOS ELEVADOS
PLATFORMS AND MEZZANINES
LAGERBÜHNEN • PLATES-FORMES ET MEZZANINES



* Kg / lb por bandeja con carga uniformemente repartida
Kg / lb per shelf uniformly distributed load
Kg / lb pro fach bei gleichmäßig verteilter last
Kg / lb par plateau avec charge uniformément répartie

