

180 x 90 x 30 CM

70.8" x 35.4" x 11.8" CM

MADERCLICK 5/300

ANTHRACITE

5 Años Garantía
Years Guarantee
Jahre Garantie
Ans Garantie
Anos de Garantia
SIMONRACK



180 cm (70.8")

30 cm (11.8")

90 cm (35.4")



Simon Rack
SINCE 1964 - MANUFACTURER



www.simonrack.com



EMPRESA CERTIFICADA
EN SISTEMA DE GESTION DE CALIDAD
ISO 9001:2015

INSTRUCCIONES
INSTRUCTIONS
ANLEITUNG
INSTRUCTIONS



150 kg (330 lb)

150 kg (330 lb)

750 kg (1654 lb) Total

150 kg (330 lb)

150 kg (330 lb)

150 kg (330 lb)



*MEDIDAS EN USO USED MEASUREMENTS
MASSNAHMEN IM EINSATZ MESURES EN EMPLOI MEDIDAS EM USO:
1749 x 910 x 310 mm (68.8" x 35.8 x 12.2")



ESTANTERIAS SIMON S.L. B.50.556.463
PG. ALFAMEN C/ POLIGONO C, N°3
ALFAMEN (ZARAGOZA)

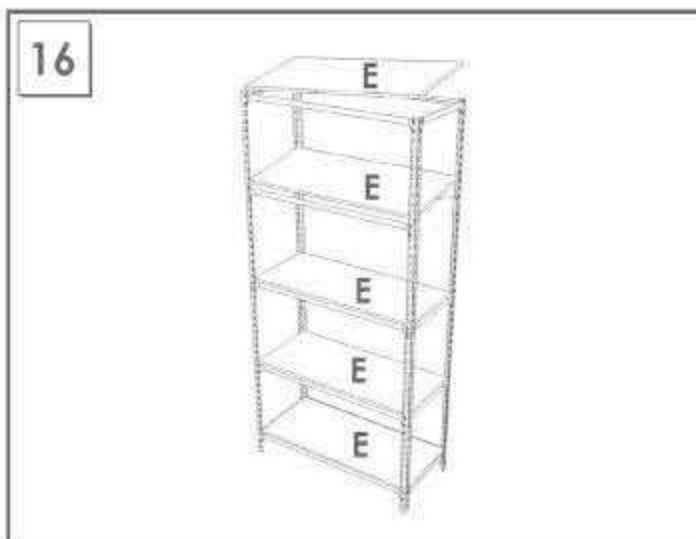
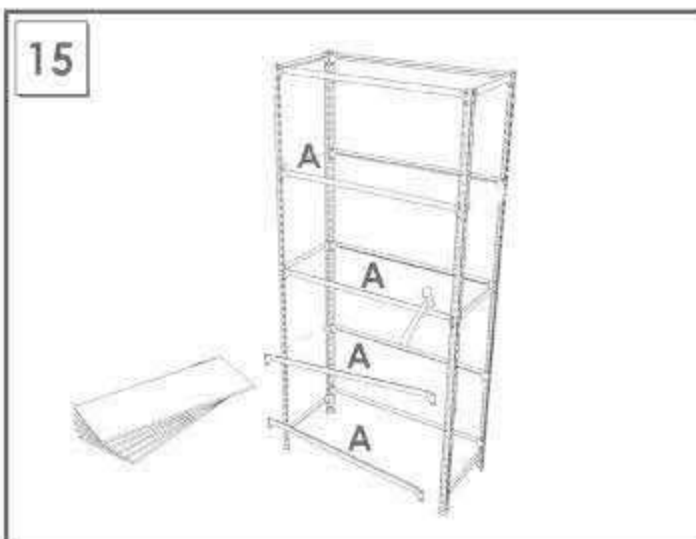
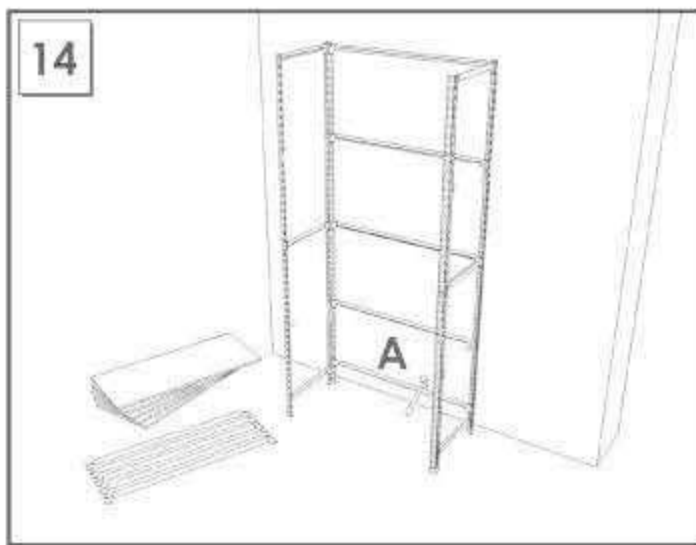
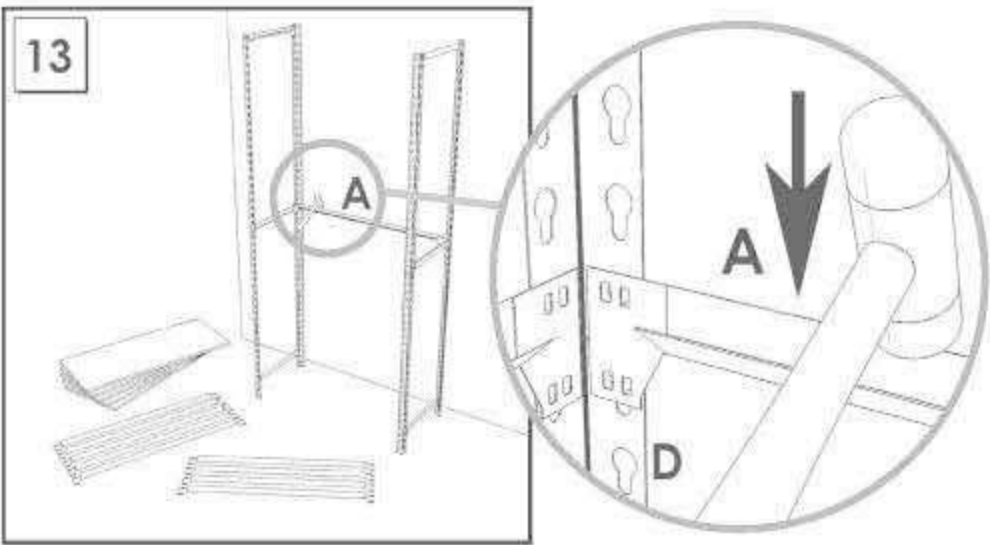
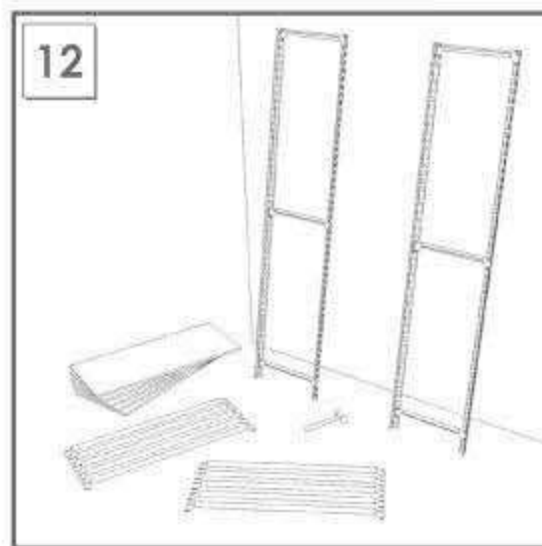
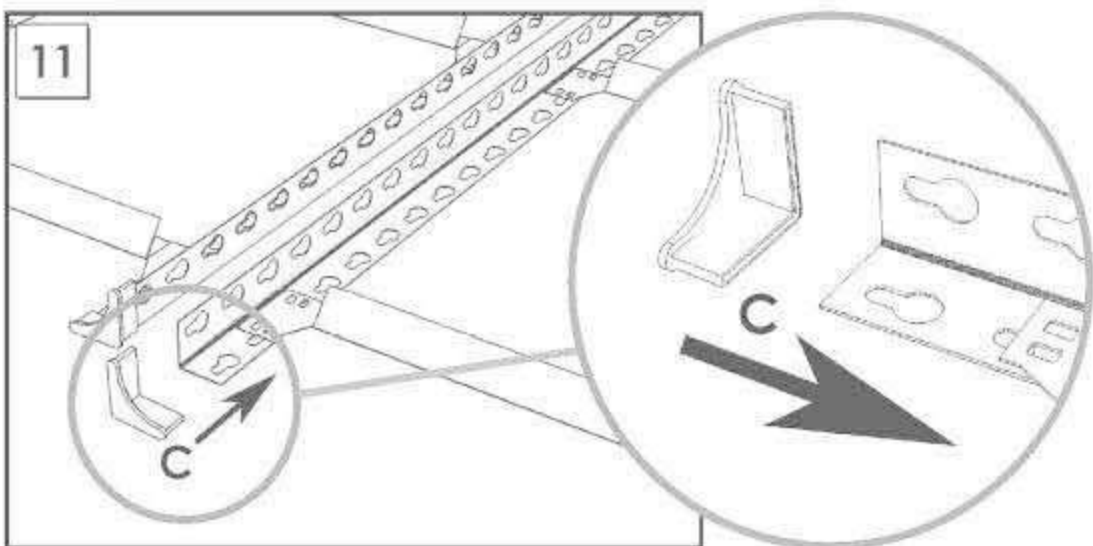
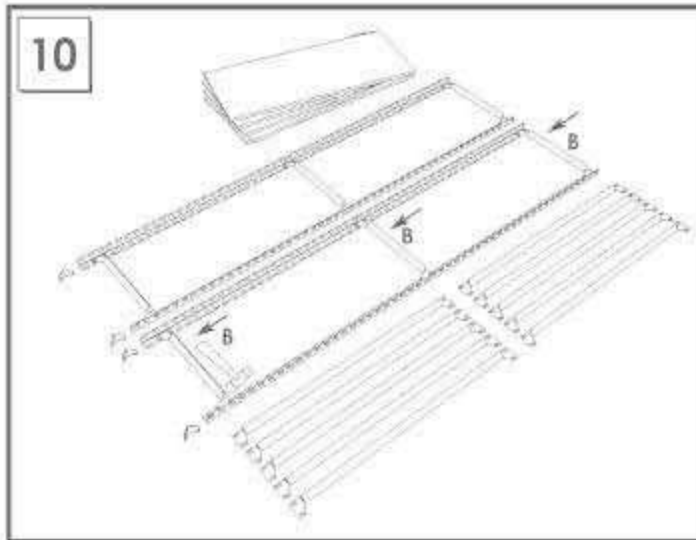
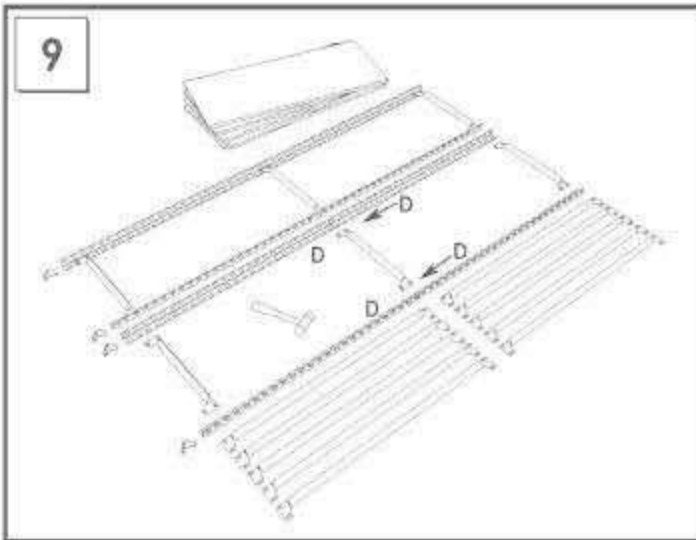
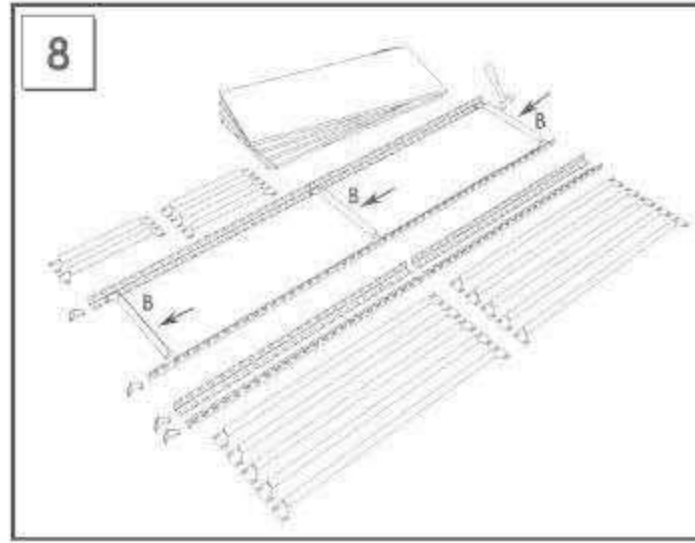
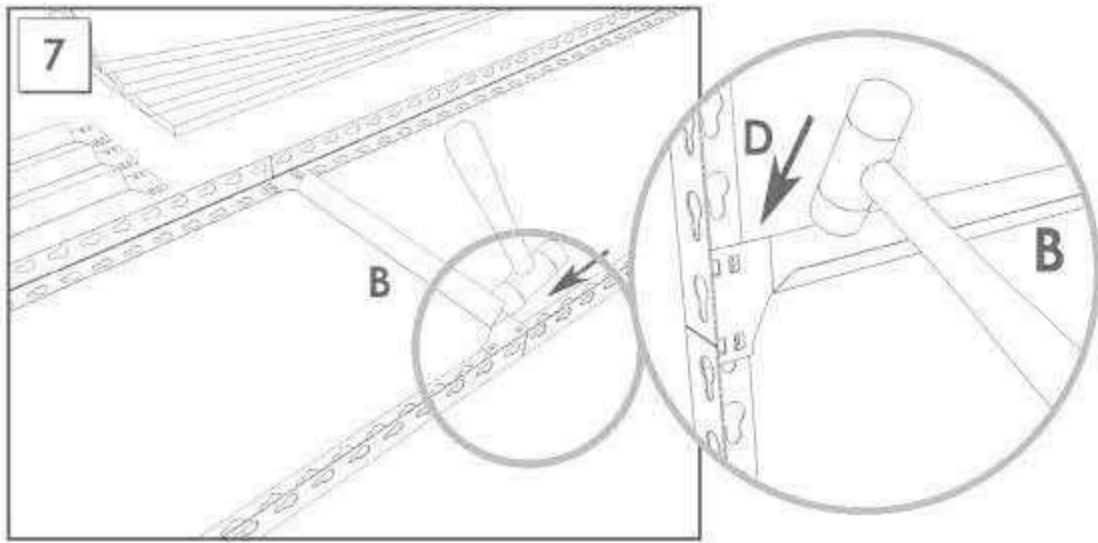
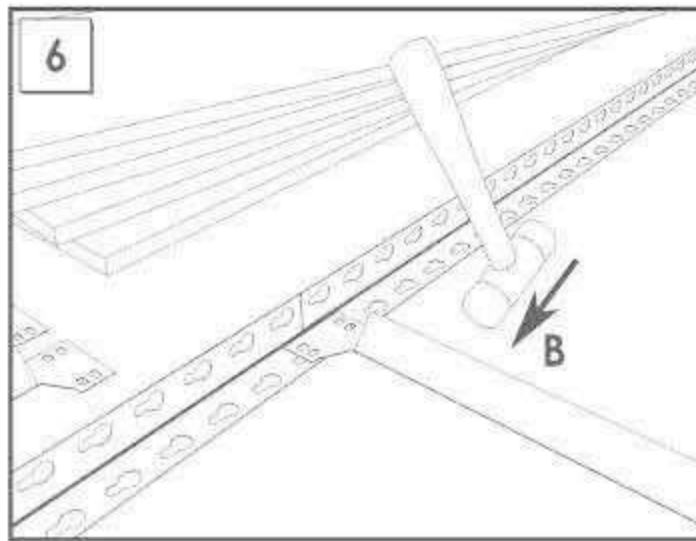
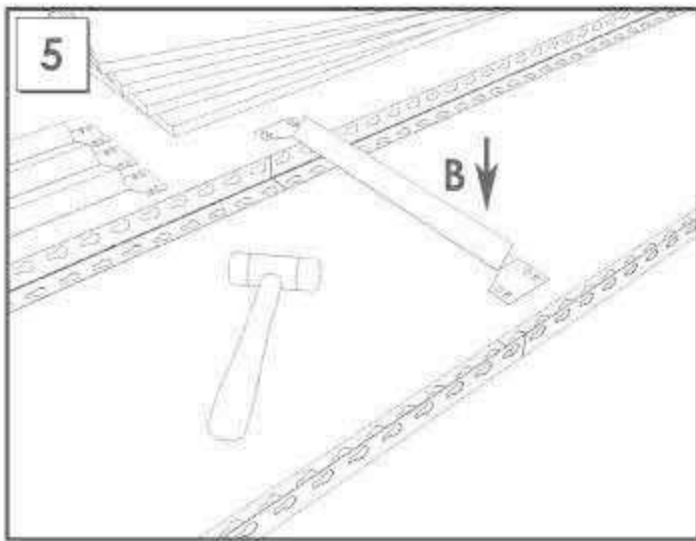
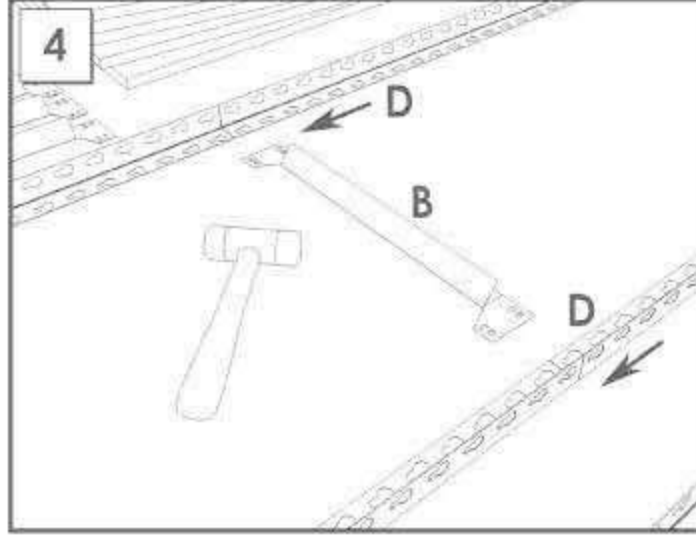
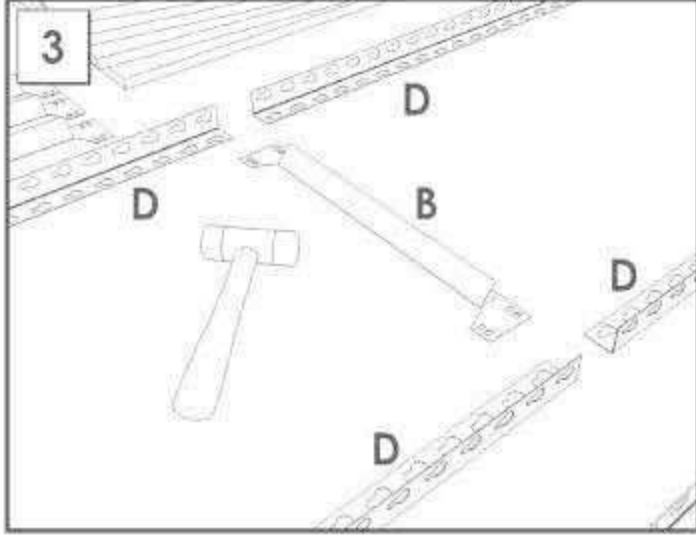
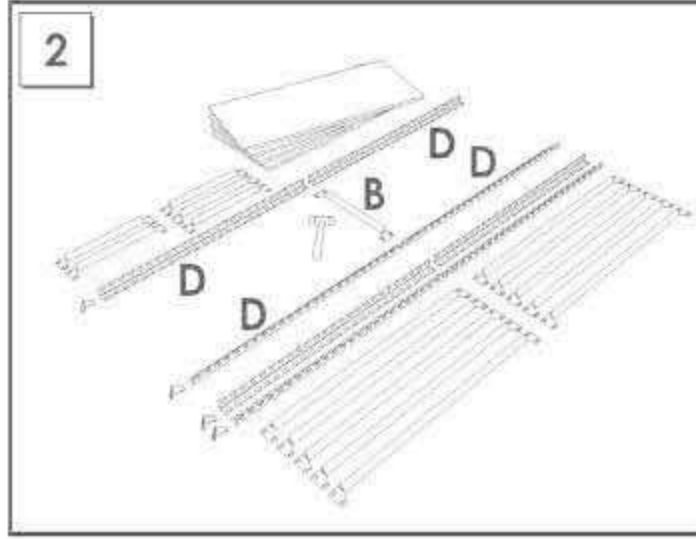
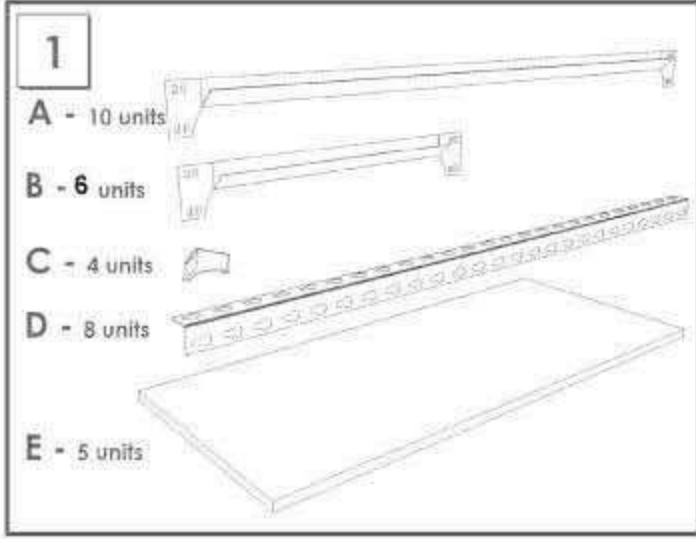

On-line instructions: www.instructionsrack.com/maderclick

SIMONCLASSIC



SIMONCLICK



SIMONOFFICE



SIMONTALLER



BANCOS DE TRABAJO
WORK BENCHES



SIMONHOME



TAQUILLAS
LOCKER



SIMONTITÁN



SIMONINOX



SIMONPALET



SIMONLEVER

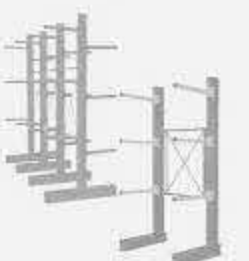

ALTILLOS Y PASILLOS ELEVADOS
PLATFORMS AND MEZZANINES

